



Molded, 25 mil or 50 mil Pitch, Dual-In-Line Thin Film Resistor, Surface Mount Network



Vishay Dale Thin Film resistor networks are designed to be used in either analog or digital circuits. The use of thin film resistive elements within the network allows you to achieve an infinite number of very low noise and high stability circuits for industrial, medical and scientific instrumentation. Vishay Dale Thin Film resistor networks are packaged in molded plastic packages with sizes that are recognized throughout the world. The rugged packaging offers superior environmental protection and consistent dimensions for ease of placement with automatic SMT equipment. Vishay Dale Thin Film stocks many designs and values for off-the-shelf convenience. With Vishay Dale Thin Film you can depend on quality products delivered on time with service backing the product.

SCHEMATICS

01 SCHEMATIC

Resistance Range:
10 Ω to 47 kΩ

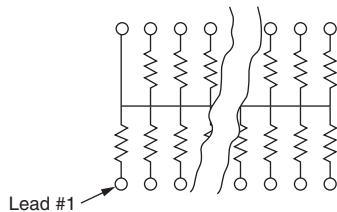

03 SCHEMATIC

Resistance Range:
10 Ω to 47 kΩ

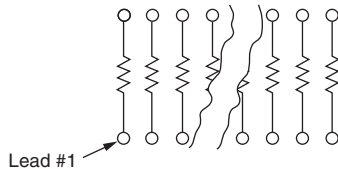

05 SCHEMATIC

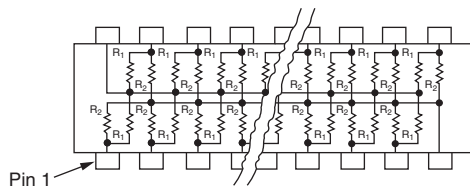

47 SCHEMATIC

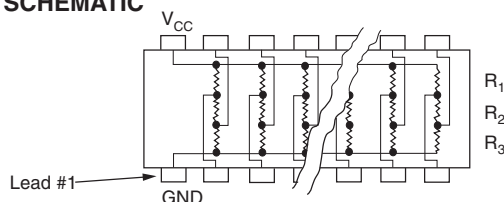

FEATURES

- Reduces total assembly costs
- Compatible with automatic surface mounting equipment
- UL 94 V-0 flame resistant
- Thin film tantalum nitride on silicon
- Choice of package sizes: VTSR (TSSOP) JEDEC® MO-153, VSSR (SSOP or QSOP) JEDEC MO-137, VSOR (SOIC narrow) JEDEC MS-012
- Moisture sensitivity level 1 (per IPC/JEDEC STD-20C)
- Isolated/bussed/dual terminator/differential terminator circuits
- Material categorization: for definitions of compliance please see www.vishay.com/doc?99912



RoHS COMPLIANT
HALOGEN FREE

TYPICAL PERFORMANCE

	ABSOLUTE	TRACKING
TCR	100	NA
	ABSOLUTE	RATIO
TOL.	5, 2, 1	NA

RESISTORS WITH ONE PIN COMMON

The 01 circuit provides nominally equal resistors connected between a common pin and a discrete PC board pin.

Commonly used in the following applications:

- MOS/ROM pull-up/-down
- Open collector pull-up
- "Wired OR" pull-up
- Power driven pull-up
- TTL input pull-down
- Digital pulse squaring
- TTL unused gate pull-up
- High speed parallels pull-up

Broad selection of standard values available

ISOLATED RESISTORS

The 03 circuit provides nominally equal resistors isolated from all others and wired directly across.

Commonly used in the following applications:

- "Wired OR" pull-up
- Power driven pull-up
- Powergate pull-up
- Line termination
- Long-line impedance balancing
- LED current limiting
- ECL output pull-down
- TTL input pull-down

Broad selection of standard values available

DUAL-LINE TERMINATOR; PULSE SQUARING

The 05 circuit contains pairs of resistors connected between ground and a common line. The junctions of these resistor pairs are connected to the input leads. The 05 circuits are designed for dual-line termination and pulse squaring.

Standard values are:

VSSR1605:
R₁ = 220 Ω, R₂ = 330 Ω
R₁ = 330 Ω, R₂ = 470 Ω

VSSR2005:
R₁ = 220 Ω, R₂ = 330 Ω
R₁ = 220 Ω, R₂ = 1.8 kΩ
R₁ = 1.5 kΩ, R₂ = 3.3 kΩ

DIFFERENTIAL TERMINATOR

The 47 schematic consists of series resistor sections connected between V_{CC} and ground. Each contains 3 resistors of 2 different resistance values.

Standard values are:

VSSR20 and VTSR20:
R₁ = 270 Ω, R₂ = 120 Ω

VSSR16 and VTSR16:
R₁ = 330 Ω, R₂ = 150 Ω
R₁ = 330 Ω, R₂ = 220 Ω



STANDARD ELECTRICAL SPECIFICATIONS		
TEST	SPECIFICATIONS	CONDITIONS
Material	Tantalum nitride	-
Pin/Lead Number	16, 20, 24	-
Resistance Range	10 Ω to 47 kΩ	Per E-24 table
TCR: Absolute	± 100 ppm/°C	-55 °C to +125 °C
TCR: Tracking	n/a	-
Tolerance: Absolute	± 5 % standard (± 2 % available) ± 1 % standard (check factory)	Per E-24 table Per E-96 table
Tolerance: Ratio	NA	-
Power Rating: Resistor	100 mW max.	At +70 °C
Power Rating: Package	16 = 1.0 W, 20 = 1.2 W, 24 = 1.4 W	0 °C to +70 °C
Stability: Absolute	-	-
Stability: Ratio	-	-
Voltage Coefficient	5 ppm/V (typical)	-
Working Voltage	50 V _{DC}	-
Operating Temperature Range	-55 °C to +125 °C	-
Storage Temperature Range	-55 °C to +150 °C	-
Noise	< -35 dB	-
Thermal EMF	-	-
Shelf Life Stability: Absolute	-	-
Shelf Life Stability: Ratio	-	-

DIMENSIONS AND IMPRINTING in inches (millimeters)

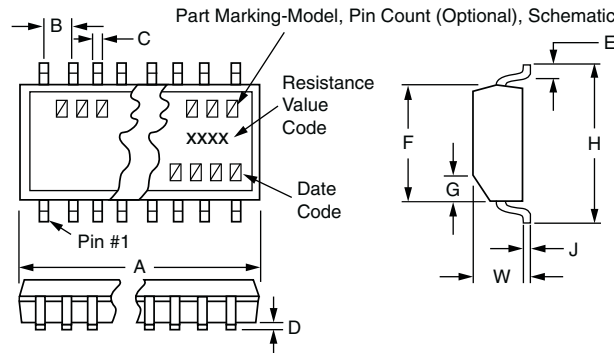

DIMENSION	VTSR-xxxx	VSSR-xxxx	VSOR-xxxx
A - 16 PIN	0.206 ± 0.003 (5.23 ± 0.08)	0.193 ± 0.004 (4.90 ± 0.010)	0.390 ± 0.010 (9.91 ± 0.25)
A - 20 PIN	0.256 ± 0.003 (6.50 ± 0.08)	0.341 ± 0.003 (8.66 ± 0.08)	NA
A - 24 PIN	0.306 ± 0.003 (7.77 ± 0.08)	0.341 ± 0.003 (8.66 ± 0.08)	NA
B (Ref.)	0.0256 (0.65)	0.025 (0.64)	0.050 (1.27)
C (Ref.)	0.0087 (0.22)	0.010 (0.25)	0.016 (0.41)
D	0.004 (0.10)	0.006 (0.15)	0.008 (0.20)
E (Typ.)	0.024 (0.61)	0.025 (0.64)	0.030 (0.76)
F	0.173 ± 0.003 (4.39 ± 0.08)	0.154 ± 0.003 (3.91 ± 0.08)	0.152 ± 0.003 (3.86 ± 0.08)
G	0.015 × 45° (0.38)	0.015 × 45° (0.38)	0.015 × 45° (0.38)
H	0.252 ± 0.005 (6.40 ± 0.13)	0.236 ± 0.008 (5.99 ± 0.20)	0.236 ± 0.005 (5.99 ± 0.13)
J (Ref.)	0.005 (0.13)	0.010 (0.25)	0.008 (0.20)
W	0.043 ± 0.005 (1.09 ± 0.13)	0.064 ± 0.005 (1.63 ± 0.13)	0.064 ± 0.005 (1.63 ± 0.13)

MARKING

MODEL	PIN COUNT (Optional)	SCHEMATIC	RESISTANCE	RESISTANCE	DATE CODE
VXXX	XX	XX	XXXX	XXX	XXXX
VSOR	16	01, 03,	1 % RESISTANCE	OR 1 %, 2 %, 5 % RESISTANCE e.g.: 103 = 10K The first 2 digits are significant figures, the last digit specifies the number of zeros to follow.	
VSSR	20	05 or 47	e.g.: 43R2		
VTSR	24		4 digits are used to express ohmic values only less than 100 Ω. R is used to designate the decimal position		



MECHANICAL SPECIFICATIONS	
Resistive Element	Tantalum nitride
Substrate Material	Silicon
Body	Molded epoxy
Terminals	Copper alloy
Plating	100 % matte tin
Lead Coplanarity	0.0005"
Marking Resistance to Solvents	Permanency testing per MIL-STD-202, method 215

PACKAGING INFORMATION			
MODEL	LEADS	TAPE AND REEL	TUBES
VTSR (TSSOP)	16	2500	94
	20	2500	74
	24	2500	62
VSSR (QSOP)	16	2500	98
	20	2500	55
	24	2500	55
VSOR (SOIC)	16	2500	48

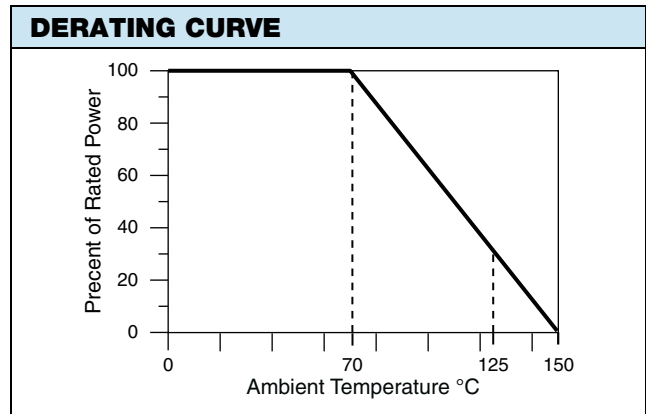

GLOBAL PART NUMBER INFORMATION

New Global Part Numbering: **VTSR1601103JTF**

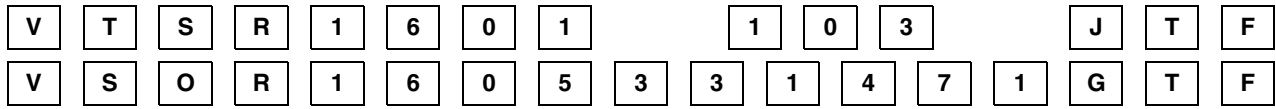

GLOBAL MODEL	PIN COUNT	SCHEMATIC	RESISTANCE (3, 4 or 6 digits)	TOLERANCE	PACKAGING
VTSR VSSR VSOR Lead (Pb)-free (e3) date code > 2705	20 (not VSOR) 24 (not VSOR)	01 (bussed) 03 (isolated)	XXX: ≥ 100R and all 1 %, 2 % and 5 % First 2 digits are significant figures. Last digit specifies number of zeros to follow. XXXX: < 100R 1 % First 3 digits are significant figures. Last digit specifies number of zeros to follow.	F = 1.0 % G = 2.0 % J = 5.0 %	TAPE AND REEL TF = Full reel 2500 UF = Tubed
	16 (not VTSR) 20 (not VSOR)	05 (terminator) 47 (terminator)	xxx xxx First 2 digits are significant figures. Last digit specifies number of zeros.	G = 2.0 % J = 5.0 %	

Historical Part Number example: **VSSR2001102GT/R** (for reference purposes only)

VSSR	20	01	102	G	T/R
MODEL	PIN COUNT	SCHEMATIC	RESISTANCE	TOLERANCE	PACKAGING



Vishay Dale Thin Film Land Patterns

1. Scope

This technical note provides sample land patterns for Vishay Dale Thin Film SMT resistive products. The following drawings are based on IPC-SM-782 Surface Mount Design and Land Pattern Standard. These drawings are for reference only Vishay Thin Film recommends that the user contacts their PC board supplier for actual land patterns required. The pads are intended for lead (Pb)-free and tin / lead solder types.

2. Product Series

Thin Film Surface Mount Chip Resistors (FC, L, P, PTN, PLT, PLTT, PLTU, PAT, PATT, PNM, M/D55342 QPL Series)

0402 Land Pattern

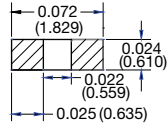

0502 Land Pattern

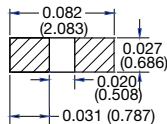

0505 Land Pattern

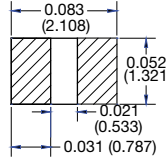

0603 Land Pattern

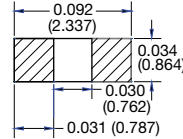

0705 Land Pattern

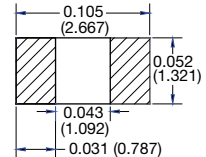

1005 Land Pattern

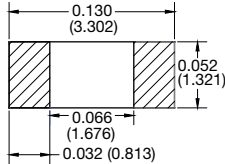

1010 Land Pattern

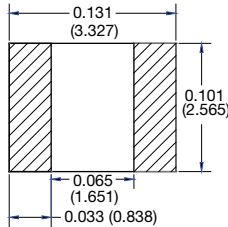

1206 Land Pattern

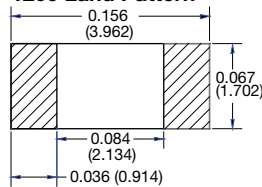

1505 Land Pattern

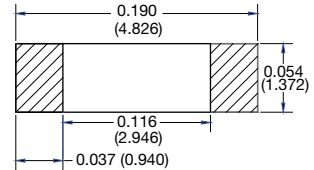

2010 Land Pattern

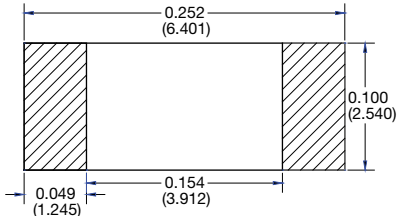

2208 Land Pattern

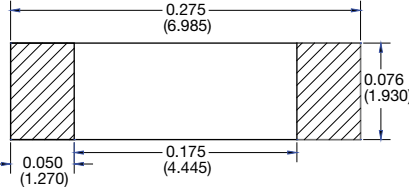

2512 Land Pattern

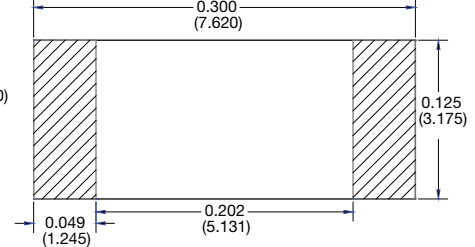



Thin Film Surface Mount Chip Resistors (PHP, PCAN Series)

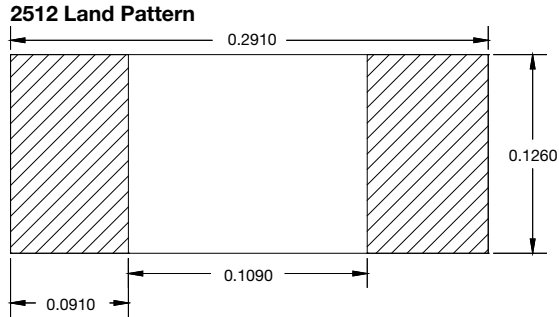
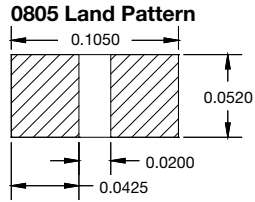
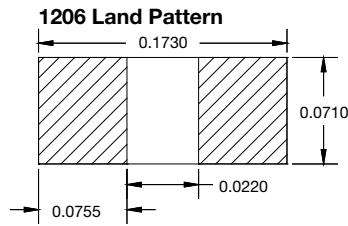
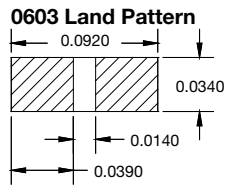

Thin Film Surface Mount Chip Resistors Long Axis Termination (L Series)

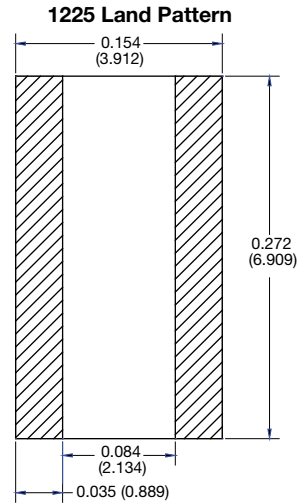
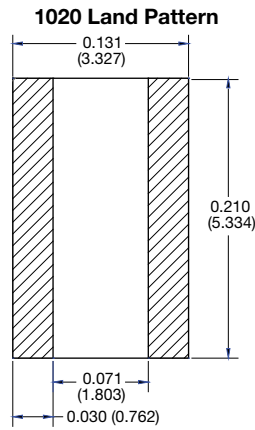
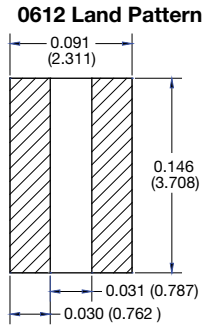
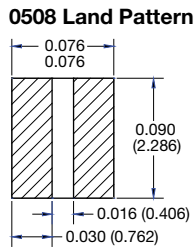



Surface Mount Networks (MPM, MP3, MP4 Series)

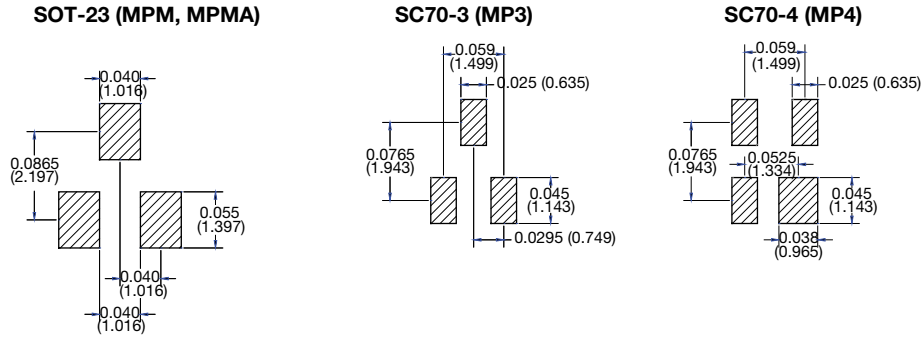

Surface Mount Networks SOIC Narrow Body 150 mils (ORN, CSO, MOMC, HTRN, AORN, MORN Series)

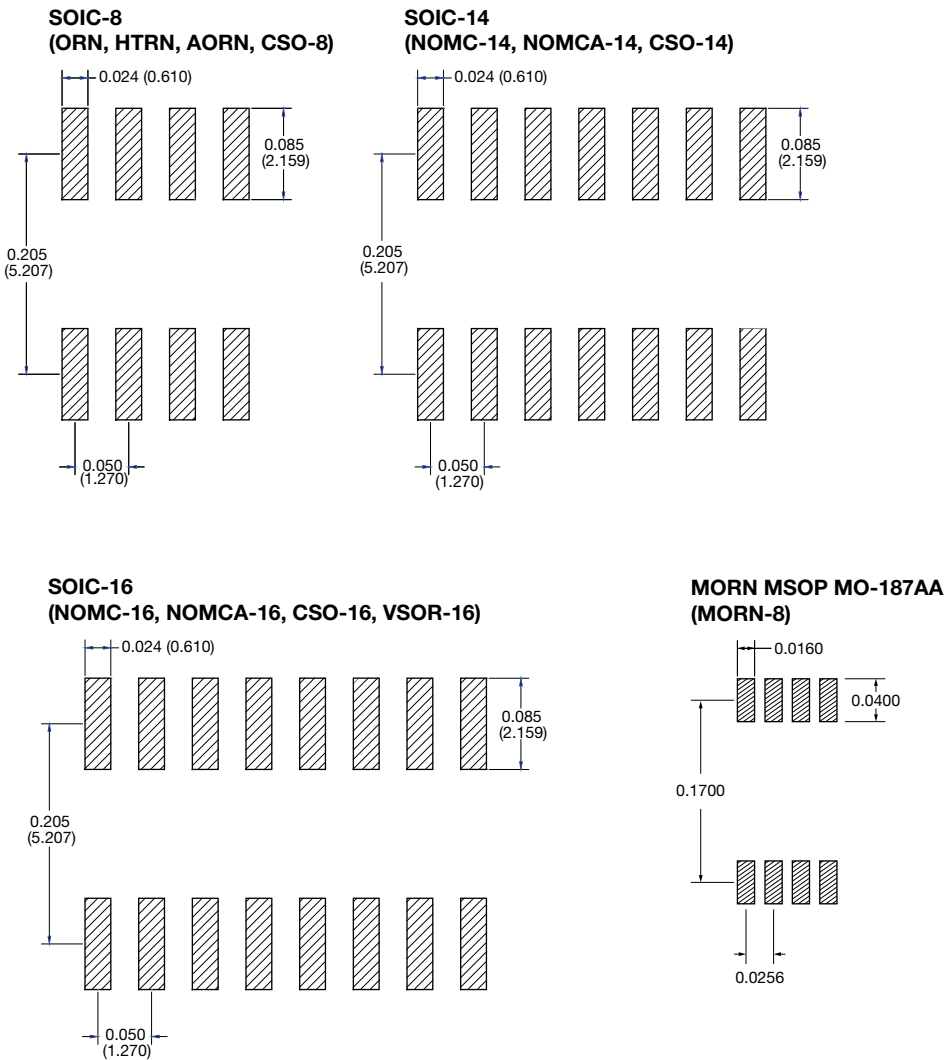



Surface Mount Networks SOIC Medium Body 220 mils (TOMC Series)

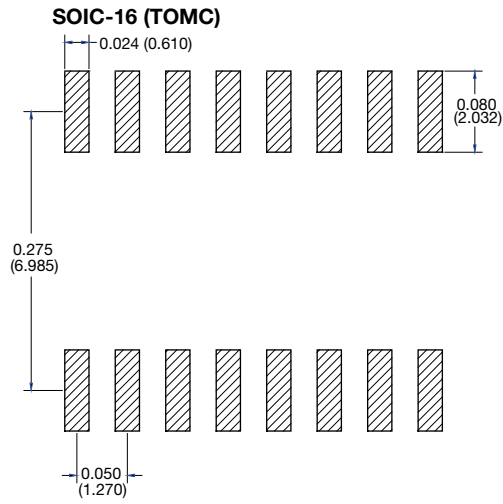

Surface Mount Networks SOIC Wide Body 300 mils (WOMC Series)

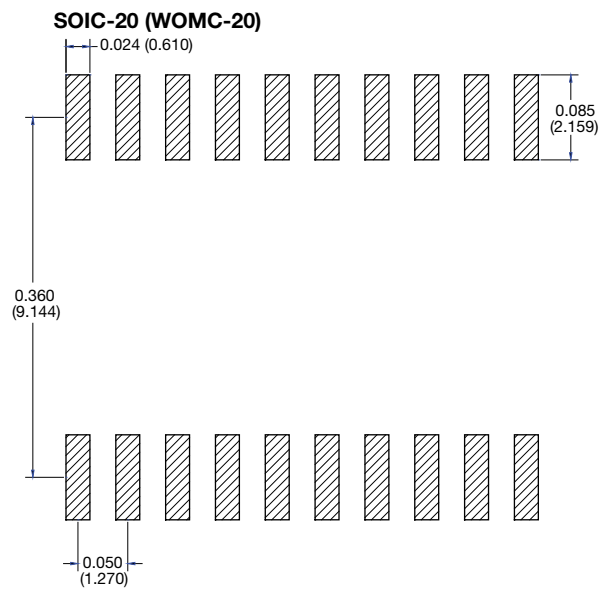
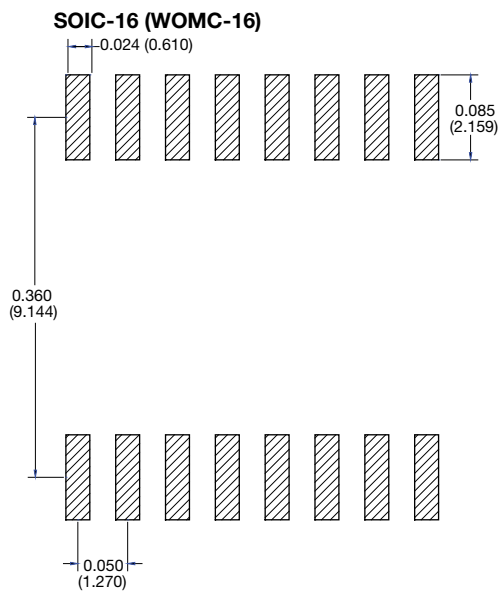



Surface Mount Networks High Density SSOP, TSOP (VSSR, VTSR Series)

SSOP MO-137

OSOP-16, VSSR-16

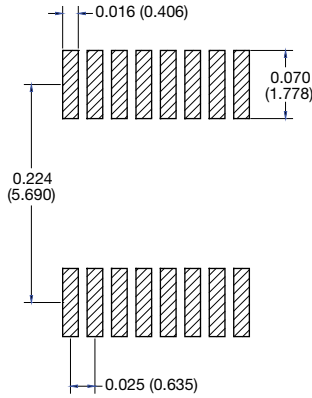

OSOP-20, VSSR-20

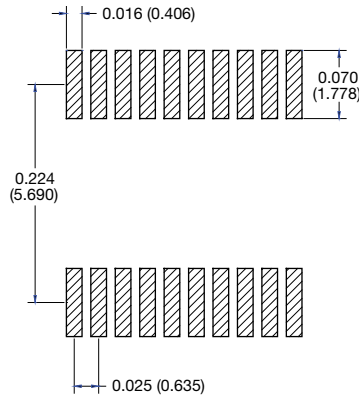

OSOP-24, VSSR-24, HD-CSO-24

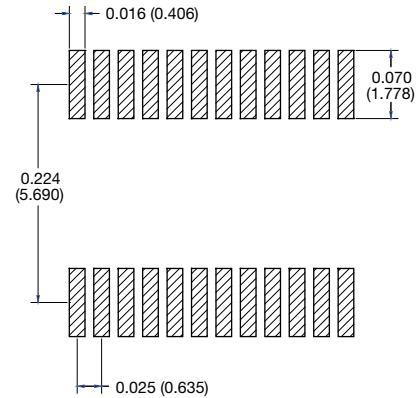

TSSOP MO-153

VTSR-16

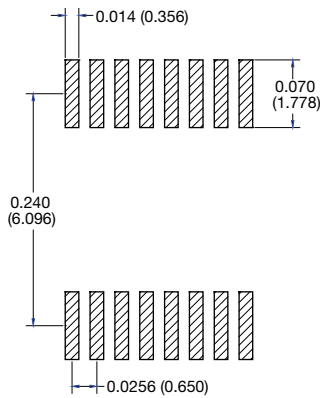

VTSR-20

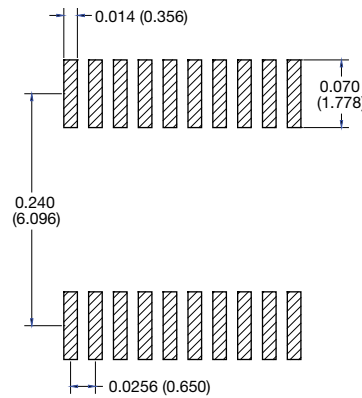

VTSR-24

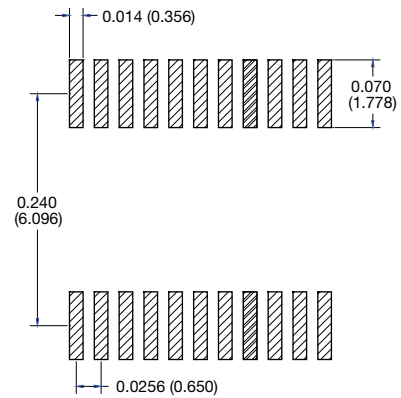

Surface Mount Leadless Networks (LCC Series)

16 Pin LCC

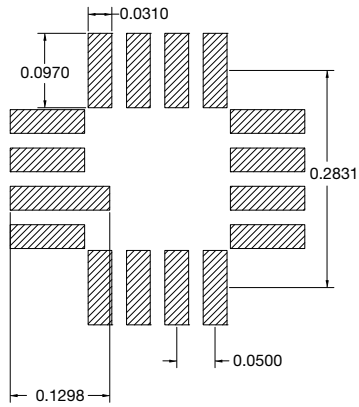

20 Pin LCC

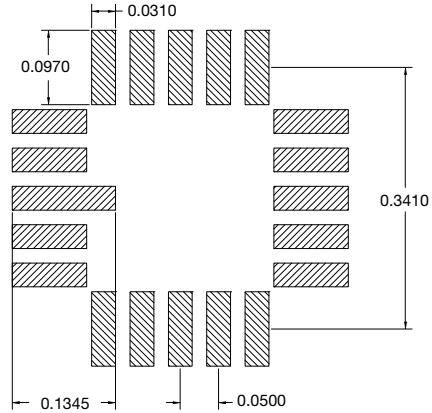

Surface Mount Leadless Networks (MPH Series)

4 Pin LCC

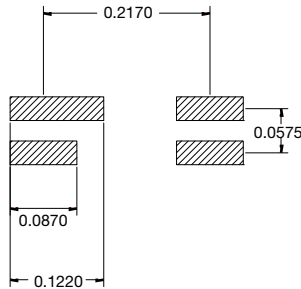

Surface Mount Leadless Packages DUAL/ QUAD Flat No Lead (DFN, QFN Series)

DFN MLP

DFN-8 4 x 5 mm Sq

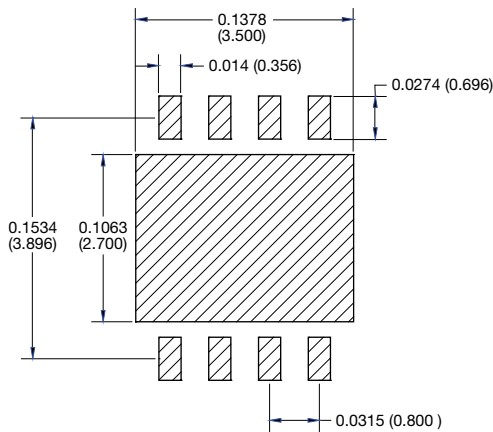

QFN MLP

QFN-20 5 x 5 mm Sq

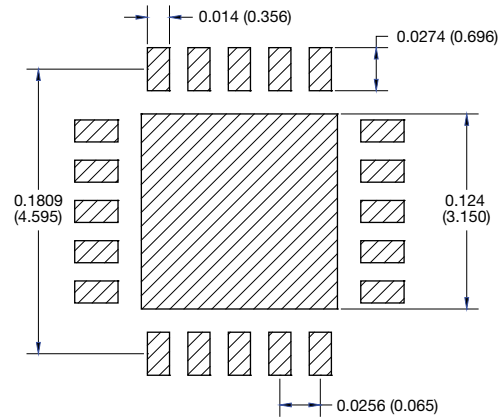



Surface Mount Leadless Resistor Arrays (PR Series)

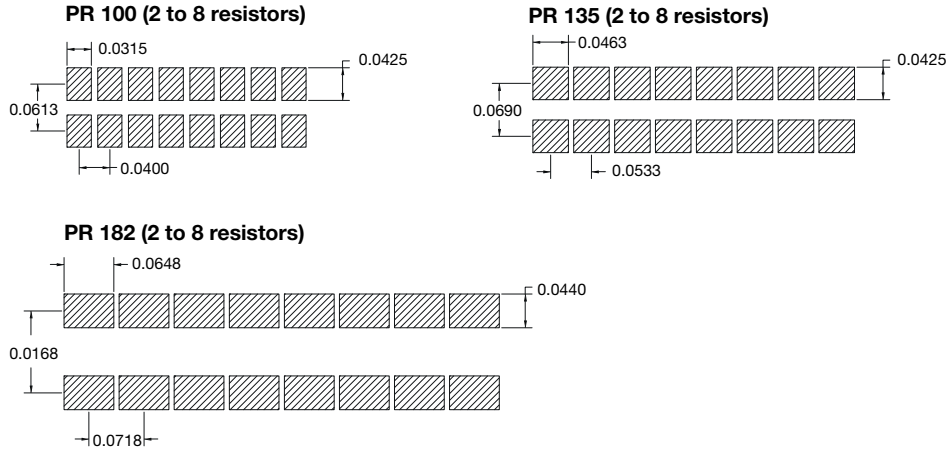

Note

- All dimensions in inches (mm)

Flatpack

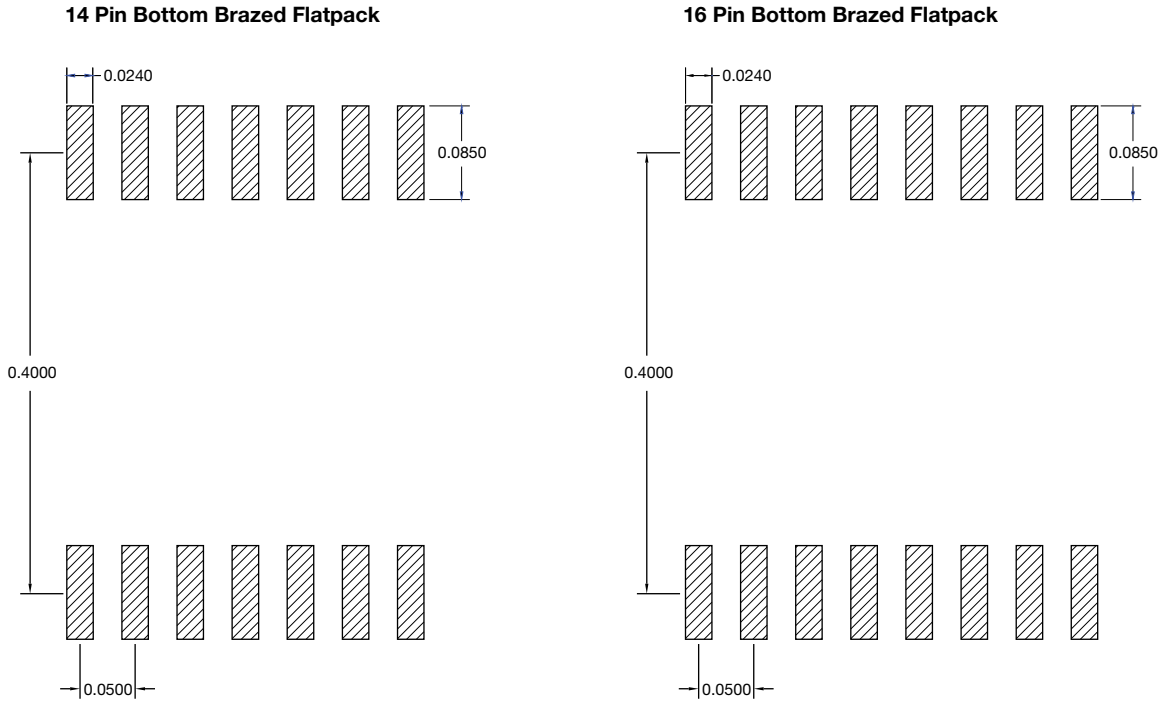



Disclaimer

ALL PRODUCT, PRODUCT SPECIFICATIONS AND DATA ARE SUBJECT TO CHANGE WITHOUT NOTICE TO IMPROVE RELIABILITY, FUNCTION OR DESIGN OR OTHERWISE.

Vishay Intertechnology, Inc., its affiliates, agents, and employees, and all persons acting on its or their behalf (collectively, "Vishay"), disclaim any and all liability for any errors, inaccuracies or incompleteness contained in any datasheet or in any other disclosure relating to any product.

Vishay makes no warranty, representation or guarantee regarding the suitability of the products for any particular purpose or the continuing production of any product. To the maximum extent permitted by applicable law, Vishay disclaims (i) any and all liability arising out of the application or use of any product, (ii) any and all liability, including without limitation special, consequential or incidental damages, and (iii) any and all implied warranties, including warranties of fitness for particular purpose, non-infringement and merchantability.

Statements regarding the suitability of products for certain types of applications are based on Vishay's knowledge of typical requirements that are often placed on Vishay products in generic applications. Such statements are not binding statements about the suitability of products for a particular application. It is the customer's responsibility to validate that a particular product with the properties described in the product specification is suitable for use in a particular application. Parameters provided in datasheets and / or specifications may vary in different applications and performance may vary over time. All operating parameters, including typical parameters, must be validated for each customer application by the customer's technical experts. Product specifications do not expand or otherwise modify Vishay's terms and conditions of purchase, including but not limited to the warranty expressed therein.

Except as expressly indicated in writing, Vishay products are not designed for use in medical, life-saving, or life-sustaining applications or for any other application in which the failure of the Vishay product could result in personal injury or death. Customers using or selling Vishay products not expressly indicated for use in such applications do so at their own risk. Please contact authorized Vishay personnel to obtain written terms and conditions regarding products designed for such applications.

No license, express or implied, by estoppel or otherwise, to any intellectual property rights is granted by this document or by any conduct of Vishay. Product names and markings noted herein may be trademarks of their respective owners.